

DÜRFFEN

de *principio a fin*



Bienvenidos a DÜRFFEN

En Dürfen somos especialistas en soluciones para la **línea eléctrica profesional**. Nuestros productos están diseñados para garantizar la máxima seguridad, eficiencia y durabilidad en cada proyecto. Con un portafolio robusto para las exigencias del sector industrial, comercial y residencial, asegurando un rendimiento superior.

Dürfen es confiabilidad, innovación y respaldo para el profesional que construye el futuro.

ÍNDICE

Tomas e interruptores

White delux	4
Inox	6
Black fancy	8
Doble polo	10

Extractores de aire

Extractor de aire 4",6",8"	13
----------------------------------	----

Protectores de voltaje

Protector 10A, 15A, 20A, 45A	15
------------------------------------	----

Breakers enchufables termomagnéticos

Breakers 1,2,3 P - blanco	17
Breakers 1,2,3 P - negro	18

Cajas EMT

Cajas 4x2 - 4x4	21
-----------------------	----

Tubos EMT

Tubos EMT	23
-----------------	----

Corazas flexometálicas liquid tight

Corazas 1/2",3/2",1"	25
----------------------------	----

Curvas, terminales y uniones

Curva acerada	27
Terminal acerada	28
Unión acerada	29

Rieles channel y tapas ciegas

Riel channel 4x2	31
Tapa ciega 4x2	31

Grapas

Grapa doble ala	33
Grapa hanger	33

Cable UTP

Cable UTP	35
-----------------	----

Cintas aislantes y conectores

Cintas aislantes	37
Conectores	37



GARANTÍA
10
AÑOS

TOMAS E INTERRUTORES

White deluxe, Inox, Black fancy, Doble polo

USO
INTERIOR

127-250V

BASE
METÁLICA

Características técnicas

Tomacorrientes

Corriente Máxima	15A
Tensión	125/250V
Capacidad USB	5VDC/3A

Interruptores

Corriente Máxima	10A
Tensión	127/250V
Capacidad Dimmer	3A/300W
Receptor Coaxial	50 Ω
Receptor RJ45	CAT 5E/6
Timbre Zumbador	110V



WHITE DELUX



-  Color Blanco
-  Dimensiones 12 X 8cm
-  Tensión 125-250V
-  Corriente Máx 15 A

**TOMA DOBLE POLO TIERRA
WHITE DELUX**

ZFR783



-  Color Blanco
-  Dimensiones 12 X 8cm
-  Tensión 125-250V
-  Tensión 5VDC
-  Corriente Máx 15 A/3A

**TOMA DOBLE POLO TIERRA
+ USB X2 WHITE DELUX**

ZFR791



-  Color Blanco
-  Dimensiones 12 X 8cm
-  Tensión 125-250V
-  Corriente Máx 10 A (i)
15 A (t)

**TOMA + INTERRUPTOR
WHITE DELUX**

ZFR789

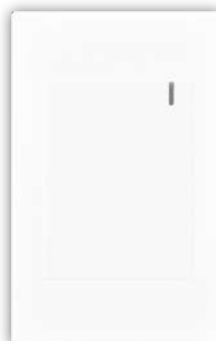

-  Color Blanco
-  Dimensiones 12 X 8cm
-  Tensión 125-250V
-  Corriente Máx 10 A

**INTERRUPTOR SENCILLO
CONMUTABLE WHITE DELUX**

ZFR784



-  Color Blanco
-  Dimensiones 12 X 8cm
-  Tensión 125-250V
-  Corriente Máx 10 A

**INTERRUPTOR DOBLE
CONMUTABLE WHITE DELUX**

ZFR785



-  Color Blanco
-  Dimensiones 12 X 8cm
-  Tensión 125-250V
-  Corriente Máx 10 A

**INTERRUPTOR TRIPLE
CONMUTABLE WHITE DELUX**

ZFR786



- Color Blanco
- Dimensiones 12 X 8cm
- Tensión 125-250V
- Corriente Máx 10 A

**PULSADOR SENCILLO
WHITE DELUX**

ZFR790



- Color Blanco
- Dimensiones 12 X 8cm
- Tipo de cable RJ-M
- Corriente Máx 10 A

**TOMA RJ45
WHITE DELUX**

ZFR792



- Color Blanco
- Dimensiones 12 X 8cm
- Tensión 125-250V
- Corriente Máx 3 A/300W

**DIMMER
WHITE DELUX**

ZFR793



- Color Blanco
- Dimensiones 12 X 8cm
- Tipo de cable RG-59
- Impedancia 50 Ω

**TOMA COAXIAL
WHITE DELUX**

ZFR787



- Color Blanco
- Dimensiones 12 X 8cm
- Tensión 125-250V
- Corriente Máx 10 A



**PLACA CIEGA
WHITE DELUX**

ZFR788



INOX







-  Color Gris
-  Dimensiones 12 X 8cm
-  Tensión 125-250V
-  Corriente Máx 15 A

**TOMA DOBLE POLO TIERRA
INOX**

ZFR772



-  Color Gris
-  Dimensiones 12 X 8cm
-  Tensión 125-250V
-  Tensión 5VDC
-  Corriente Máx 15 A/3A

**TOMA DOBLE POLO TIERRA
+ USB X2 INOX**

ZFR782



-  Color Gris
-  Dimensiones 12 X 8cm
-  Tensión 125-250V
-  Corriente Máx 10 A (i)
15 A (t)

**TOMA + INTERRUPTOR
INOX**

ZFR777







-  Color Gris
-  Dimensiones 12 X 8cm
-  Tensión 125-250V
-  Corriente Máx 10 A

**INTERRUPTOR SENCILLO
CONMUTABLE INOX**

ZFR773



-  Color Gris
-  Dimensiones 12 X 8cm
-  Tensión 125-250V
-  Corriente Máx 10 A

**INTERRUPTOR DOBLE
CONMUTABLE INOX**

ZFR774





-  Color Gris
-  Dimensiones 12 X 8cm
-  Tensión 125-250V
-  Corriente Máx 10 A

**INTERRUPTOR TRIPLE
CONMUTABLE INOX**

ZFR775



 Color Gris

 Dimensiones 12 X 8cm

 Tensión 125-250V

 Corriente Máx 10 A

**PULSADOR SENCILLO
INOX**
ZFR779



 Color Gris

 Dimensiones 12 X 8cm

 Tipo de cable RJ-M

 Corriente Máx 10 A

**TOMA RJ45
INOX**
ZFR780



 Color Gris

 Dimensiones 12 X 8cm

 Tensión 125-250V

 Corriente Máx 3 A/300W

**DIMMER
INOX**
ZFR781



 Color Gris

 Dimensiones 12 X 8cm

 Tipo de cable RG-59

 Impedancia 50 Ω

**TOMA COAXIAL
INOX**
ZFR776



 Color Gris

 Dimensiones 12 X 8cm

 Tensión 125-250V

 Corriente Máx 10 A

**PLACA CIEGA
INOX**
ZFR778



BLACK FANCY



-  Color Negro
-  Dimensiones 12 X 8cm
-  Tensión 125-250V
-  Corriente Máx 15 A

**TOMA DOBLE POLO TIERRA
BLACK FANCY**
ZFR761



-  Color Negro
-  Dimensiones 12 X 8cm
-  Tensión 125-250V
-  Tensión 5VDC
-  Corriente Máx 15 A/3A

**TOMA DOBLE POLO TIERRA
+ USB X2 BLACK FANCY**
ZFR767



-  Color Negro
-  Dimensiones 12 X 8cm
-  Tensión 125-250V
-  Corriente Máx 10 A (i)
15 A (t)

**TOMA + INTERRUPTOR
BLACK FANCY**
ZFR764



-  Color Negro
-  Dimensiones 12 X 8cm
-  Tensión 125-250V
-  Corriente Máx 10 A

**INTERRUPTOR SENCILLO
CONMUTABLE BLACK FANCY**
ZFR762



-  Color Negro
-  Dimensiones 12 X 8cm
-  Tensión 125-250V
-  Corriente Máx 10 A

**INTERRUPTOR DOBLE
CONMUTABLE BLACK FANCY**
ZFR763



-  Color Negro
-  Dimensiones 12 X 8cm
-  Tensión 125-250V
-  Corriente Máx 10 A

**INTERRUPTOR TRIPLE
CONMUTABLE BLACK FANCY**
ZFR765



 Color Negro

 Dimensiones 12 X 8cm

 Tensión 125-250V

 Corriente Máx 10 A

**PULSADOR SENCILLO
BLACK FANCY**
ZFR769



 Color Negro

 Dimensiones 12 X 8cm

 Tipo de cable RJ-M

 Corriente Máx 10 A

**TOMA RJ45
BLACK FANCY**
ZFR770



 Color Negro

 Dimensiones 12 X 8cm

 Tensión 125-250V

 Corriente Máx 3 A/300W

**DIMMER
BLACK FANCY**
ZFR771



 Color Negro

 Dimensiones 12 X 8cm

 Tipo de cable RG-59

 Impedancia 50 Ω

**TOMA COAXIAL
BLACK FANCY**
ZFR766



 Color Negro

 Dimensiones 12 X 8cm

 Tensión 125-250V

 Corriente Máx 10 A

**PLACA CIEGA
BLACK FANCY**
ZFR768



DOBLE POLO



Color Blanco

Tensión 125-250V

Corriente Máx 15 A

**TOMA DOBLE BLANCA
REGULADA/SEGURIDAD**

ZFR751

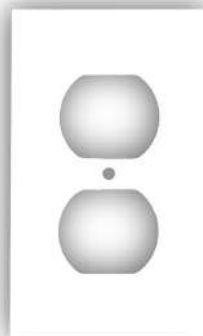

**TAPA BLANCA
TOMA DOBLE**

ZFR752



Color Naranja

Tensión 125-250V

Corriente Máx 15 A

**TOMA DOBLE NARANJA
HOSPITALARIA/REGULADA**

ZFR750



**TAPA NARANJA
TOMA DOBLE**

ZFR753



DÜRFFEN



EXTRACTORES DE AIRE

4", 6", 8"

TENSIÓN
110-120V

FRECUENCIA
50-60HZ

IP
20

MATERIAL
ABS

EXTRACTORES DE AIRE

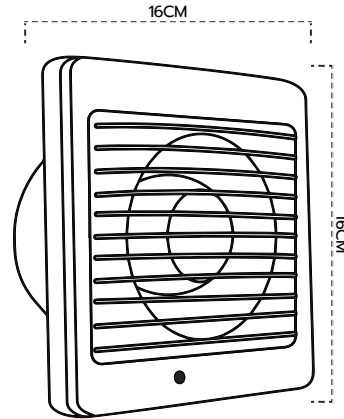

**EXTRACTOR DE AIRE 4"
CON REJILLA BLANCO**

ZFR329

CORRIENTE NOMINAL	POTENCIA	RPM	FLUJO DE AIRE	NÚMERO DE ASPAS
0.13 A	15W	2300	125 m³/h	6

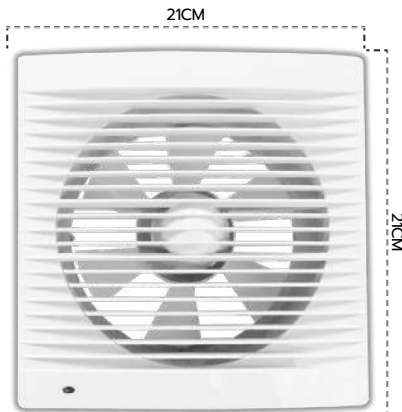

**EXTRACTOR DE AIRE 6"
CON REJILLA BLANCO**

ZFR330

CORRIENTE NOMINAL	POTENCIA	RPM	FLUJO DE AIRE	NÚMERO DE ASPAS
512 A	20W	1600	294 m³/h	7

**EXTRACTOR DE AIRE 8"
CON REJILLA BLANCO**

ZFR331

CORRIENTE NOMINAL	POTENCIA	RPM	FLUJO DE AIRE	NÚMERO DE ASPAS
0.17 A	20W	1724	317 m³/h	6

Es un equipo **diseñado para mejorar la ventilación de espacios cerrados**, facilitando la circulación del aire y la eliminación de humedad, humo, olores y partículas en suspensión.

Su funcionamiento **contribuye a mantener ambientes más frescos, limpios y saludables**, tanto en hogares como en áreas comerciales o industriales, fabricado con materiales resistentes y de fácil instalación, **ofrece un desempeño eficiente y silencioso, ideal para garantizar confort y bienestar** en distintos entornos.



PROTECTORES DE VOLTAJE

10A, 15A, 20A, 45A

TEMPERATURA
-5° - 45° C

IP
20

FRECUENCIA
50-60HZ

VIDA ÚTIL
**25000
HORAS**



**PROTECTOR DE VOLTAJE
10A - 1200W - 120 VAC**

ZFR592

POTENCIA MÁXIMA	CORRIENTE MÁXIMA	TENSIÓN	RANGO DE PROTECCIÓN	FRECUENCIA
1200 W	10A	120 VAC	90 VAC 140 VAC	50-60HZ



**PROTECTOR DE VOLTAJE
15A - 1800W - 120 VAC**

ZFR593

POTENCIA MÁXIMA	CORRIENTE MÁXIMA	TENSIÓN	RANGO DE PROTECCIÓN	FRECUENCIA
1800 W	15A	120 VAC	90 VAC 140 VAC	50-60HZ



**PROTECTOR DE VOLTAJE
15A - 1800W - 120 VAC**

ZFR594

POTENCIA MÁXIMA	CORRIENTE MÁXIMA	TENSIÓN	RANGO DE PROTECCIÓN	FRECUENCIA
1800 W	15A	120 VAC	90 VAC 140 VAC	50-60HZ



**PROTECTOR DE VOLTAJE
20A - 2400W - 120 VAC**

ZFR595

POTENCIA MÁXIMA	CORRIENTE MÁXIMA	TENSIÓN	RANGO DE PROTECCIÓN	FRECUENCIA
2400 W	20A	120 VAC	90 VAC 140 VAC	50-60HZ



**PROTECTOR DE VOLTAJE
20A - 4400W - 220 VAC**

ZFR596

POTENCIA MÁXIMA	CORRIENTE MÁXIMA	TENSIÓN	RANGO DE PROTECCIÓN	FRECUENCIA
4400 W	20A	220 VAC	Ajustable	50-60HZ



**PROTECTOR DE VOLTAJE
45A - 9900W - 120 VAC**

ZFR597

POTENCIA MÁXIMA	CORRIENTE MÁXIMA	TENSIÓN	RANGO DE PROTECCIÓN	FRECUENCIA
9900 W	45A	220 VAC	170 VAC 270 VAC	50-60HZ



GARANTÍA
10
AÑOS

BREAKERS ENCHUFABLES TERMOMAGNÉTICOS

CURVA DE
DISPARO
TIPO C

IP
20

TECNOLOGÍA
**PLUG-IN
BREAKER**

TEMPERATURA
-5° - 45° C



BREAKERS ENCHUFABLES



BREAKER 1P ENCHUFABLE



CUMPLE
NORMA
RETIE



	SKU	CORRIENTE MÁX	TIEMPO DE DISPARO
 Color Blanco	ZFR692	15	10-15 seg
 Dimensiones 2,5X7,8cm	ZFR693	20	12-18 seg
	ZFR694	30	14-20 seg
 Tensión 120-240V	ZFR695	40	16-22 seg
	ZFR696	50	17-23 seg
	ZFR697	60	18-24 seg





BREAKER 2P ENCHUFABLE

	SKU	CORRIENTE MÁX	TIEMPO DE DISPARO
 Color Blanco	ZFR698	20	2-10 seg
 Dimensiones 5X7,8cm	ZFR699	30	4-12 seg
	ZFR700	40	6-14 seg
 Tensión 120-240V	ZFR701	50	8-16 seg



BREAKER 3P ENCHUFABLE

	SKU	CORRIENTE MÁX	TIEMPO DE DISPARO
 Color Blanco	ZFR702	20	2-10 seg
 Dimensiones 7,5X7,8cm	ZFR703	30	4-12 seg
	ZFR704	40	6-14 seg
 Tensión 120-240V	ZFR705	50	8-16 seg

BREAKERS ENCHUFABLES



BREAKER 1P ENCHUFABLE

CUMPLE
NORMA
RETIE



	SKU	CORRIENTE MÁX	TIEMPO DE DISPARO
Color Negro	ZFR678	15	10-15 seg
Dimensiones 2,5X7,8cm	ZFR679	20	12-18 seg
	ZFR680	30	14-20 seg
	ZFR681	40	16-22 seg
Tensión 125-240V	ZFR682	50	17-23 seg
	ZFR683	60	18-24 seg



BREAKER 2P ENCHUFABLE

	SKU	CORRIENTE MÁX	TIEMPO DE DISPARO
Color Negro	ZFR684	20	2-10 seg
Dimensiones 5X7,8cm	ZFR685	30	4-12 seg
	ZFR686	40	6-14 seg
Tensión 125-240V	ZFR687	50	8-16 seg



BREAKER 3P ENCHUFABLE

	SKU	CORRIENTE MÁX	TIEMPO DE DISPARO
Color Negro	ZFR688	20	2-10 seg
Dimensiones 5X7,8cm	ZFR689	30	4-12 seg
	ZFR690	40	6-14 seg
Tensión 120-240V	ZFR691	50	8-16 seg



DÜRFFEN



CAJAS EMT

4x2, 4x4, Octagonal

**ALTA
RESISTENCIA**

**FÁCIL
INSTALACIÓN**

**ACERO
GALVANIZADO**

**RESISTE
CORROSIÓN**

CAJAS EMT



SKU	PULGADAS
ZFR260	1/2"
ZFR262	3/4"

**CAJA 4X2
3 SALIDAS**



SKU	PULGADAS
ZFR261	1/2"
ZFR263	3/4"
ZFR264	1"

**CAJA 4X2
5 SALIDAS**



SKU	PULGADAS
ZFR265	1/2"
ZFR267	3/4"

**CAJA 4X4
3 SALIDAS**



SKU	PULGADAS
ZFR266	1/2"
ZFR268	3/4"
ZFR269	1"

**CAJA 4X4
5 SALIDAS**



SKU	PULGADAS
ZFR270	1/2"
ZFR271	3/4"

**CAJA
OCTAGONAL**

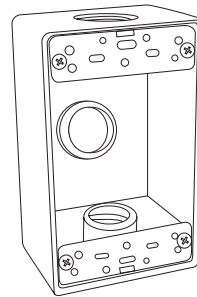

TUBOS EMT

USO
EXTERIOR
INTERIOR

MOLDEABLE
HASTA
90°

FÁCIL
INSTALACIÓN

TUBOS EMT



SKU	PULGADAS	ESPEJOR	LONGITUD	PESO
ZFR372	1/2"	1,1 mm	3,05 m	1,44 kg
ZFR373	3/4"	1,3 mm	3,05 m	2,21 kg
ZFR374	1"	1,5 mm	3,05 m	3,21 kg
ZFR491	1 1/4"	1,7 mm	3,05 m	4,76 kg
ZFR492	1 1/2"	1,7 mm	3,05 m	5,48 kg
ZFR493	2"	1,7 mm	3,05 m	6,96 kg

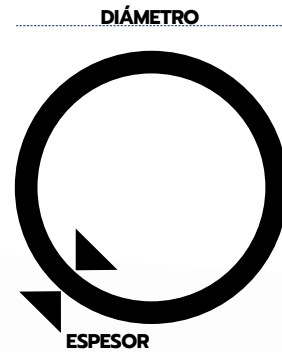

ENSAYOS A LOS QUE SON SOMETIDOS:

- Ensayo de inflamabilidad
- Ensayo de tracción
- Ensayo de impacto frio
- Ensayo de pruebas químicas
- Ensayo de pruebas de adhesión

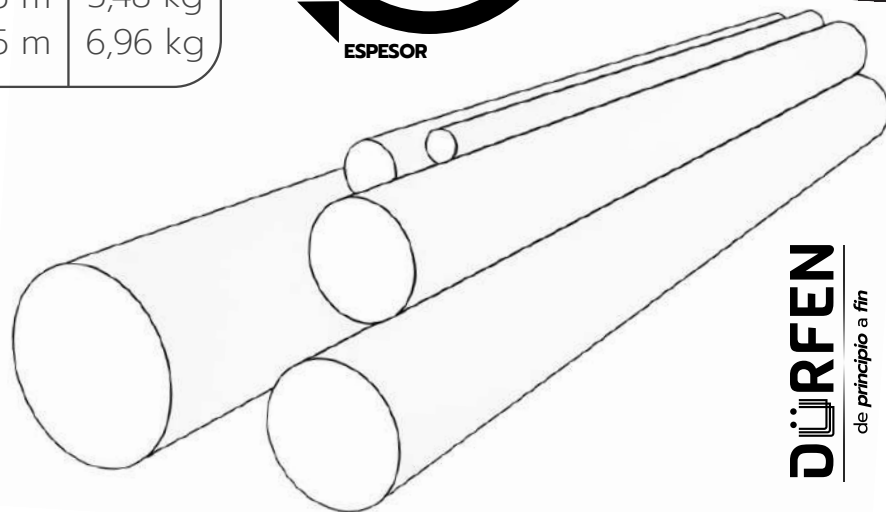

TUBOS EMT

DÜR FEN
de principio a fin



CORAZAS FLEXOMETÁLICAS LIQUID TIGHT

CUBIERTA
EXTERIOR
PVC

AMBIENTES
HUMEDOS

FLEXIBLE

RESISTE
CORROSIÓN

CORAZAS FLEXOMETÁLICAS LIQUID TIGHT

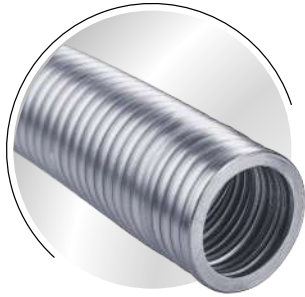

**CORAZA FLEXOMETALICA
LIQUID TIGHT**
1/2" ROLLO X100MTS
ZFR580



**CORAZA FLEXOMETALICA
LIQUID TIGHT**
3/2" ROLLO X100MTS
ZFR581



**CORAZA FLEXOMETALICA
LIQUID TIGHT**
1" ROLLO X100MTS
ZFR582

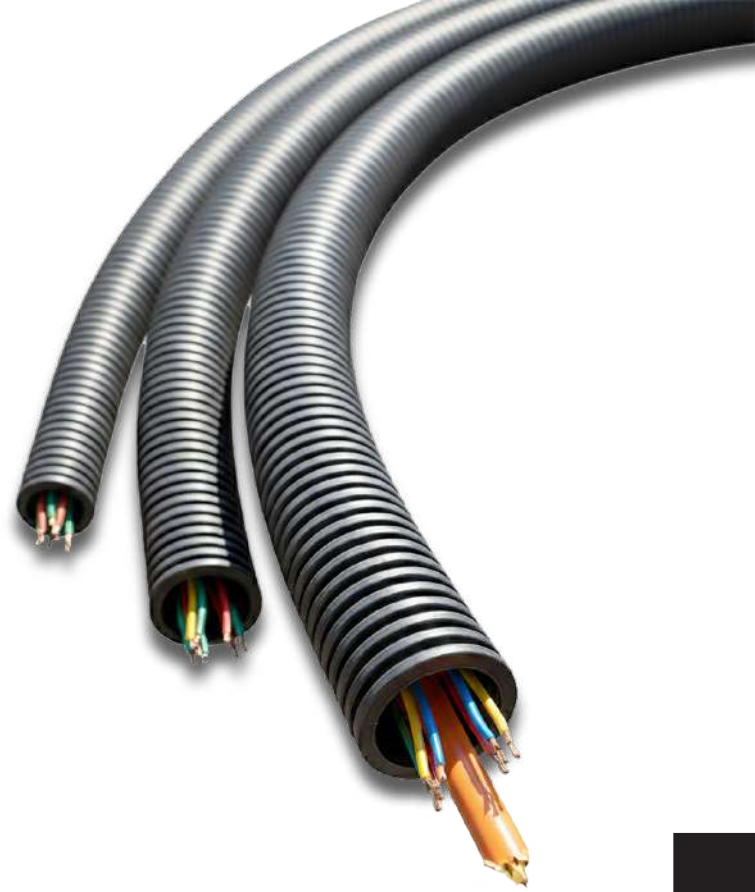

Es una **tubería flexible fabricada en acero galvanizado** engargolado de alta resistencia. Su diseño helicoidal ofrece una excelente maniobrabilidad y adaptabilidad, facilitando la instalación en trayectorias curvas o con obstáculos. Proporciona una sólida **protección mecánica al cableado eléctrico contra impactos, aplastamiento y roedores en ambientes interiores y secos.**



CURVAS, TERMINALES Y UNIONES

CONTINUIDAD
ELÉCTRICA

INSTALACIÓN
SEGURA

FÁCIL
INSTALACIÓN

RESISTE
CORROSIÓN



CURVAS



Longitud de Curva



CURVA ACERADA 1/2"

Longitud de curva: 21,5 cm
ZFR251

CURVA ACERADA 3/2"

Longitud de curva: 23,5 cm
ZFR252

CURVA ACERADA 1"

Longitud de curva: 28,5 cm
ZFR253

La Curva Acerada **es un accesorio preformado de alta resistencia**, fabricado en acero galvanizado, **diseñado para realizar cambios de dirección precisos y suaves** en las canalizaciones eléctricas.

Su interior liso y uniforme protege los cables contra la abrasión durante el halado, **garantizando una instalación segura y profesional**

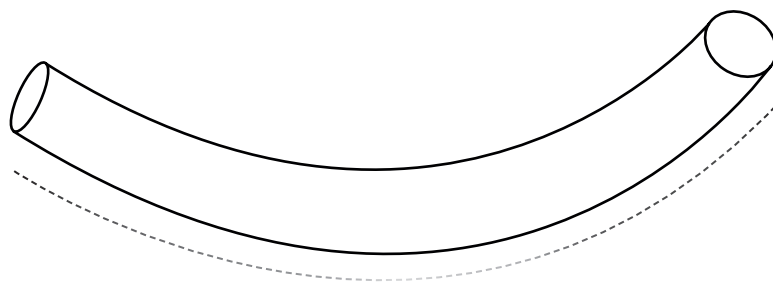

Longitud de curva

TERMINALES

CUMPLE
NORMA
RETIE



TERMINAL ACERADA 1/2"

Longitud de
curva: 21,5 cm
ZFR254

TERMINAL ACERADA 3/2"

Longitud de
curva: 23,5 cm
ZFR255

TERMINAL ACERADA 1"

Longitud de
curva: 28,5 cm
ZFR256

La Terminal Acerada es un conector de alta durabilidad, fabricado en acero galvanizado, **diseñado para unir de forma segura la tubería eléctrica** (tipo EMT) a cajas de conexión, gabinetes o paneles.

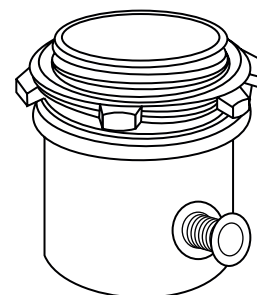

UNIONES



UNION ACERADA 1/2"
Longitud de
curva: 21,5 cm
ZFR257



UNION ACERADA 3/2"
Longitud de
curva: 23,5 cm
ZFR258



UNION ACERADA 1"
Longitud de
curva: 28,5 cm
ZFR259

La Unión Acerada es un acople robusto, fabricado en acero galvanizado, **diseñado para empalmar dos tramos de tubería eléctrica (tipo EMT) de manera rápida y segura.**

Su construcción precisa asegura una alineación perfecta y una conexión mecánica firme, protegiendo la continuidad del cableado en su interior.

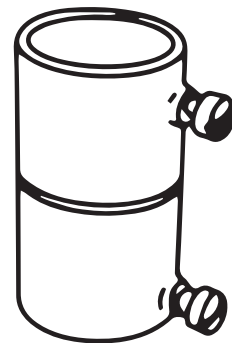



RIELES CHANNEL Y TAPAS CIEGAS

**ACERO
GALVANIZADO**

**INSTALACIÓN
SEGURA**

**FÁCIL
INSTALACIÓN**

**RESISTE
CORROSIÓN**

RIELES CHANNEL Y TAPAS CIEGAS

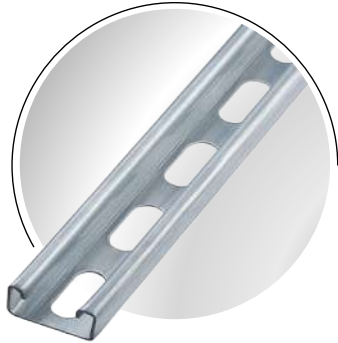

RIEL CHANEL 4X2
3 Metros
ZFR278

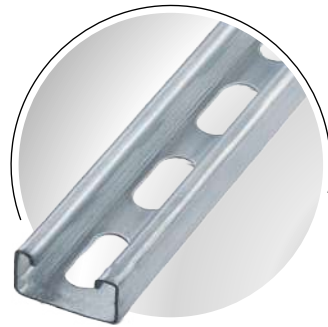

RIEL CHANEL 4X4
3 Metros
ZFR279

El **riel channel** es un perfil metálico en forma de "C", diseñado para brindar **soporte, fijación y montaje** en proyectos de construcción, instalaciones eléctricas e industriales.

Su **resistencia, versatilidad y fácil instalación** lo convierten en la **solución ideal** para estructuras modulares, sistemas de cableado y soportes de tuberías



TAPA CIEGA 4X2
ZFR272



TAPA CIEGA 4X4
ZFR273



TAPA CIEGA 4X4
ZFR274

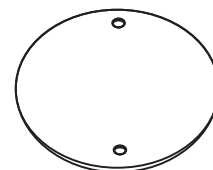
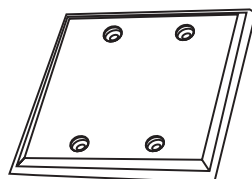
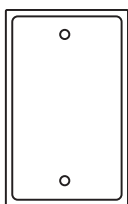

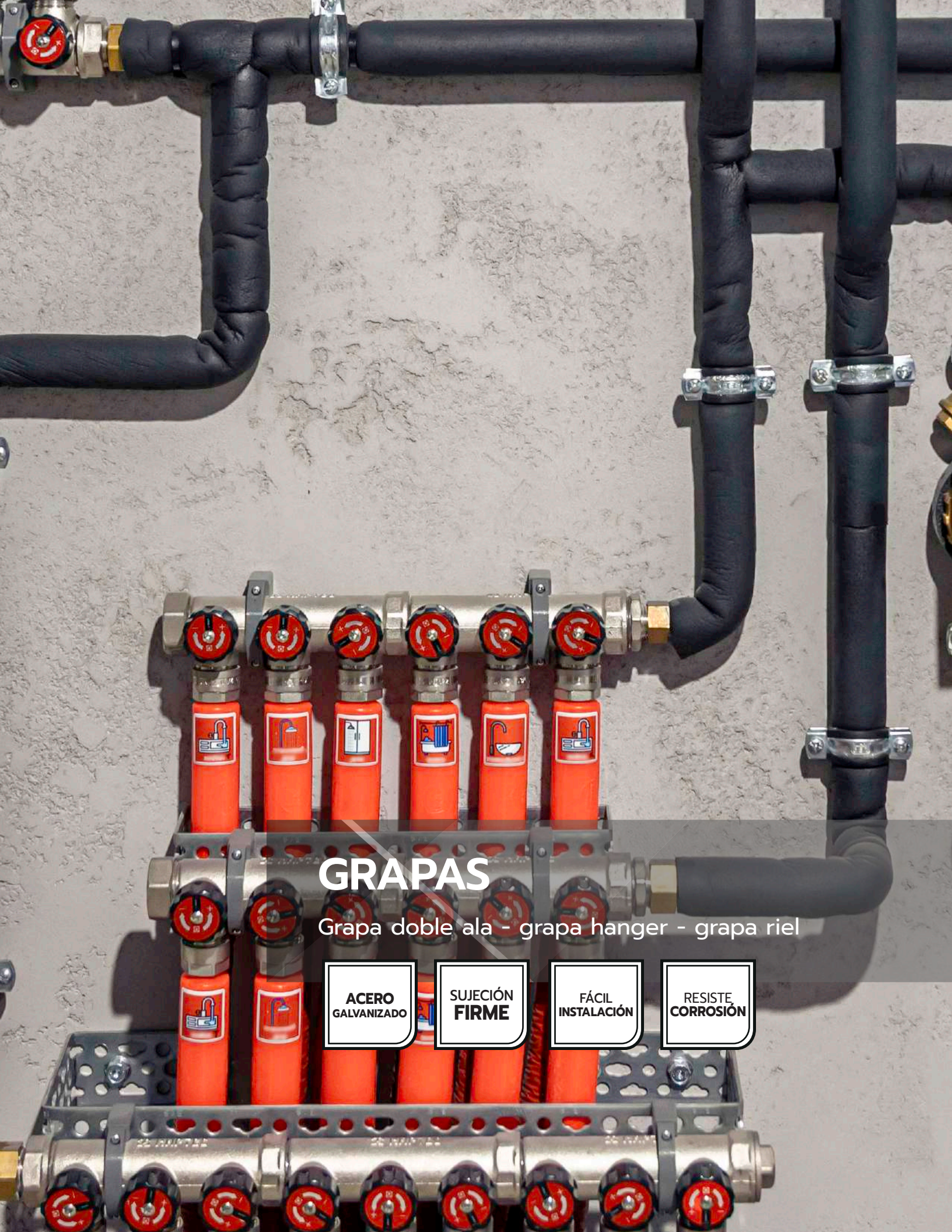

GRAPAS

Grapa doble ala - grapa hanger - grapa riel

**ACERO
GALVANIZADO**

**SUJECIÓN
FIRME**

**FÁCIL
INSTALACIÓN**

**RESISTE
CORROSIÓN**

GRAPAS



**GRAPA DOBLE
ALA 1"**
ZFR275

**GRAPA DOBLE
ALA 3/4"**
ZFR276

**GRAPA DOBLE
ALA 1/2"**
ZFR277

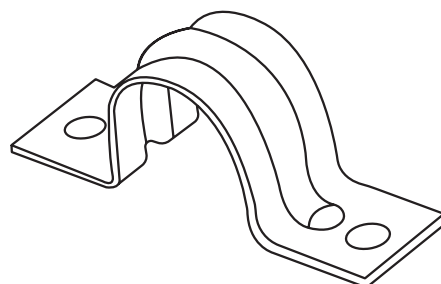

**GRAPA HANGER
1/2"**
ZFR283



**GRAPA HANGER
3/4"**
ZFR284

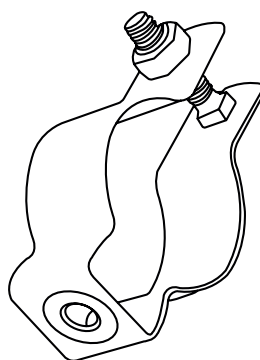

GRAPA RIEL 1/2"
ZFR280



GRAPA RIEL 3/4"
ZFR281



GRAPA RIEL 1"
ZFR282

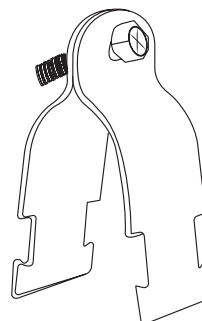

GRAPAS



CABLE UTP

5E, 6

NVP 69%
AUMENTA LA
VELOCIDAD

ROLLO
305M

100%
COBRE

4 PARES
GR

CABLE UPT 100% COBRE

CABLE UTP CAT 5E



USO INTERIOR

SKU	FRECUENCIA MÁX.	IMPEDANCIA	DIAMETRO CONDUCTOR	VELOCIDAD PROPAGACIÓN
ZFR322	100 MHZ	100Ω	22-24 AWG	1 GBPS

CABLE UTP CAT 5E



USO EXTERIOR

SKU	FRECUENCIA MÁX.	IMPEDANCIA	DIAMETRO CONDUCTOR	VELOCIDAD PROPAGACIÓN
ZFR318	100 MHZ	100Ω	22-24 AWG	1 GBPS

CABLE UTP CAT 6



USO INTERIOR

SKU	FRECUENCIA MÁX.	IMPEDANCIA	DIAMETRO CONDUCTOR	VELOCIDAD PROPAGACIÓN
ZFR323	250 MHZ	100Ω	22-24 AWG	10 GBPS

CABLE UTP CAT 6



USO EXTERIOR

SKU	FRECUENCIA MÁX.	IMPEDANCIA	DIAMETRO CONDUCTOR	VELOCIDAD PROPAGACIÓN
ZFR319	250 MHZ	100Ω	22-24 AWG	10 GBPS

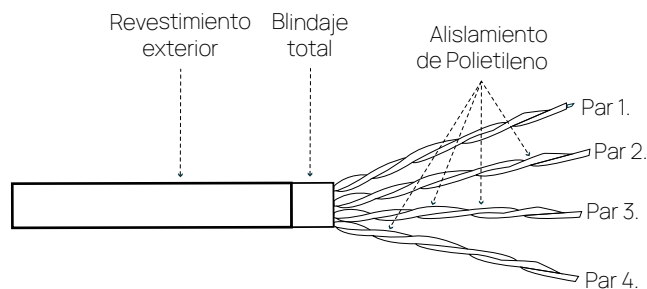

CABLE UTP



CINTAS AISLANTES Y CONECTORES

AISLAMIENTO
ÓPTIMO

ALTA
RESISTENCIA

TEMPERATURA
HASTA
80° C

CINTAS Y CONECTORES



**CINTA AISLANTE
15 MTS - BLANCA**
ZFR622



**CINTA AISLANTE
15 MTS - NEGRA**
ZFR623



**CINTA AISLANTE
15 MTS - AZUL**
ZFR621



**CINTA AISLANTE
15 MTS - ROJA**
ZFR624



**CINTA AISLANTE
15 MTS - VERDE**
ZFR625



**CINTA AISLANTE
15 MTS - NARANJA**
ZFR626



CONECTOR AMARILLO
ZFR828



CONECTOR ROJO
ZFR829



DÜRFFEN

de *principio a fin*